







Universal Frame Sizes Gi through Ji

Electrical Characteristics

Frames		Gi125			Fi100, Fi160, Fi225			Ji250		
Cutler-Hammer Universal Moulded Case Circuit Breakers										
Electrical Characteristics										
Frame (690V) / Maximum Rated Amperes		Gi125			Fi100	Fi160	Fi225	Ji250		
Interrupting Rating										
IEC 947-2	220-240 VAC I_{cu}/I_{cs}	18/5		25/7	25/13	35/18	35/18	35/18		
	380-415 VAC I_{cu}/I_{cs}	-		18/5	18/9	25/13	25/13	25/13		
	440 VAC I_{cu}/I_{cs}	-		-	14/7	20/10	20/10	20/10		
NEMA	240 VAC	18		25	25	25	25	35		
	277/480 VAC	14		14	14	14	14	20		
Number of Poles		1		2, 3	2, 3	2, 3	2, 3	3		
Continuous Ampere Rating (40°C)		15, 20, 30, 40, 60, 70, 80, 100, 125			15, 20, 30, 40, 60, 70, 80, 100	125, 150, 160	175, 200, 225	250		
Dimensions		H	W	D	H	W	D	H	W	D
mm	1-Pole	123.82	25.30	66.67	152.40	-	86.00	254.00	-	103.17
	2-Pole		51.00			70.00			-	
	3-Pole		73.50			104.77			104.77	
Inches	1-Pole	4.87	1.00	2.62	6.00	-	3.37	10.00	-	4.06
	2-Pole		2.00			2.75			-	
	3-Pole		3.00			4.12			4.12	
Weight (Approximate)		1-Pole	2-Pole	3-Pole	2-Pole	3-Pole	3-Pole			
Kilograms		0.34	0.6	0.8	1.8	2.4	5.2			
Pounds		0.75	1	1.33	3	4.5	12.5			

Universal Frame Sizes K_i through L_i

Electrical Characteristics

Frames		K_i400			L_i630			L_i800		
<p>Cutler-Hammer Universal Moulded Case Circuit Breakers</p>										
Electrical Characteristics										
Frame (690V) / Maximum Rated Amperes		K_i400			L_i630			L_i800		
Interrupting Rating										
IEC 947-2	220-240 VAC I_{CU}/I_{CS}	35/18			35/18			42/21		
	380-415 VAC I_{CU}/I_{CS}	25/13			25/13			35/18		
	440 VAC I_{CU}/I_{CS}	20/10			20/10			30/15		
NEMA	240 VAC	35			35			42		
	277/480 VAC	20			20			30		
Number of Poles		3			3			3		
Continuous Ampere Rating (40°C)		300, 350, 400			500, 600, 630			700, 800		
Dimensions		H	W	D	H	W	D	H	W	D
mm	1-Pole	257.17	-	109.55	273.10	-	111.10	406.40	-	111.10
	2-Pole		-			-				
	3-Pole		139.45			209.60				
Inches	1-Pole	10.12	-	4.31	10.75	-	4.37	16.00	-	4.37
	2-Pole		-			-				
	3-Pole		5.49			8.25				
Weight (Approximate)		3-Pole			3-Pole			3-Pole		
		Kilograms			9.4			11.3		
		Pounds			21.5			24.9		

Universal Frame Sizes Gi through Li

Selection Guide and Ordering Information

Catalogue Numbers

When ordering Universal Breakers, use the appropriate catalogue numbers given below.

Frames/Ampere Rating	Catalogue Numbers		
	1-Pole	2-Pole	3-Pole
Gi125/15-125 Amperes	Gi1015 Gi1020 Gi1030 Gi1040 Gi1050 Gi1060 Gi1070 Gi1080 Gi1100 Gi1125	Gi2015 Gi2020 Gi2030 Gi2040 Gi2050 Gi2060 Gi2070 Gi2080 Gi2100 Gi2125	Gi3015 Gi3020 Gi3030 Gi3040 Gi3050 Gi3060 Gi3070 Gi3080 Gi3100 Gi3125
Fi100/15-100 Amperes		Fi2015 Fi2020 Fi2030 Fi2040 Fi2050 Fi2060 Fi2070 Fi2080 Fi2100	Fi3015 Fi3020 Fi3030 Fi3040 Fi3050 Fi3060 Fi3070 Fi3080 Fi3100
Fi160/125-160 Amperes		Fi2125 Fi2150 Fi2160	Fi3125 Fi3150 Fi3160
Fi225/175-225 Amperes		Fi2175 Fi2200 Fi2225	Fi3175 Fi3200 Fi3225
Ji250/250 Amperes			Ji3250
Ki400/300-400 Amperes			Ki3300 Ki3350 Ki3400
Li630/500-630 Amperes			Li3500 Li3600 Li3630
Li800/700-800 Amperes			Li3700 Li3800W

Base Mounting Hardware

Metric base mounting hardware is included with each breaker. English mounting hardware is available for field installation only.

Frames	Catalogue Numbers	
	English	Metric
Gi-Frame ^②	—	—
Fi-Frame	BMH1	BMH1M
Ji-Frame	BMH2	BMH2M
Ki-Frame	BMH3	BMH3M
Li-Frame	BMH4	BMH4M

Line and Load Terminals

Both line and load terminals are included with Gi-Frame Universal Breakers.

Frames	Amperes	Terminal Type	Wire Type	Wire Range
Gi	15-125	Pressure	Cu	4-50 #10 AWG

End Cap Accessory Kit

End caps for line and load conductor termination are included with each breaker. End caps secure the conductor with a ring-type connector. The kit includes one end cap, three cap screws, three nuts, and three lock washers.

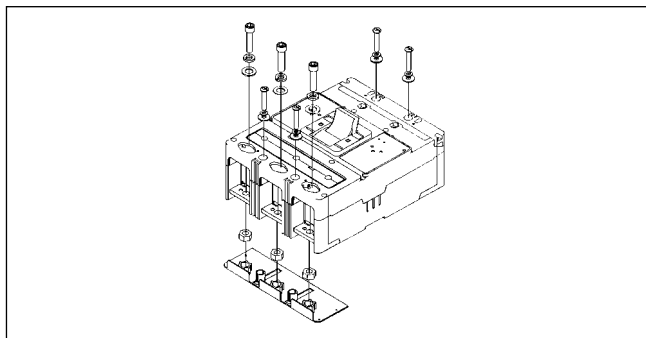

Optional Line and Load Terminals

Compression terminals with hardware are available for a wide range of conductors. Field installation only.

Frames	Ampere Rating	Terminal Type	Wire Type	Wire Range	Catalogue Number
Fi	15-20	Pressure	Cu/Al	2.5-4 #14-#10	3T20FB ^①
	30-100	Pressure	Cu/Al	2.5-50 #14-1/0	3T100FB ^①
	160	Pressure	Cu/Al	25-95 #4-4/0	3TA150FB ^①
	225	Pressure	Cu/Al	25-95 #4-4/0	3TA225FD ^①
Ji	250	Pressure	Cu/Al	25-250 #4-350 MCM	TA250KB
Ki	350	Pressure	Cu/Al	150-240 (1) 250-500 MCM	TA350K
	400	Pressure	Cu/Al	70-120 (2) 3/0-250 MCM	3TA400K ^①
	400	Pressure	Cu/Al	70-120 (2) 250-500 MCM or 150-240 (1) 250-500 MCM	3TA401K ^①
Li	500	Pressure	Cu/Al	120-150 (2) 250-350	TA602LD
	600	Pressure	Cu/Al	185-250 (2) 400-50	3TA603LDK ^①
	800	(Line and load bus extension included.)			

^① Package of 3 terminals.

^② Base mounting hardware, applicable to both NEMA and IEC applications, is included with Gi-Frame Breakers. A separate catalogue number is not required.